

ASSEMBLY INSTRUCTIONS

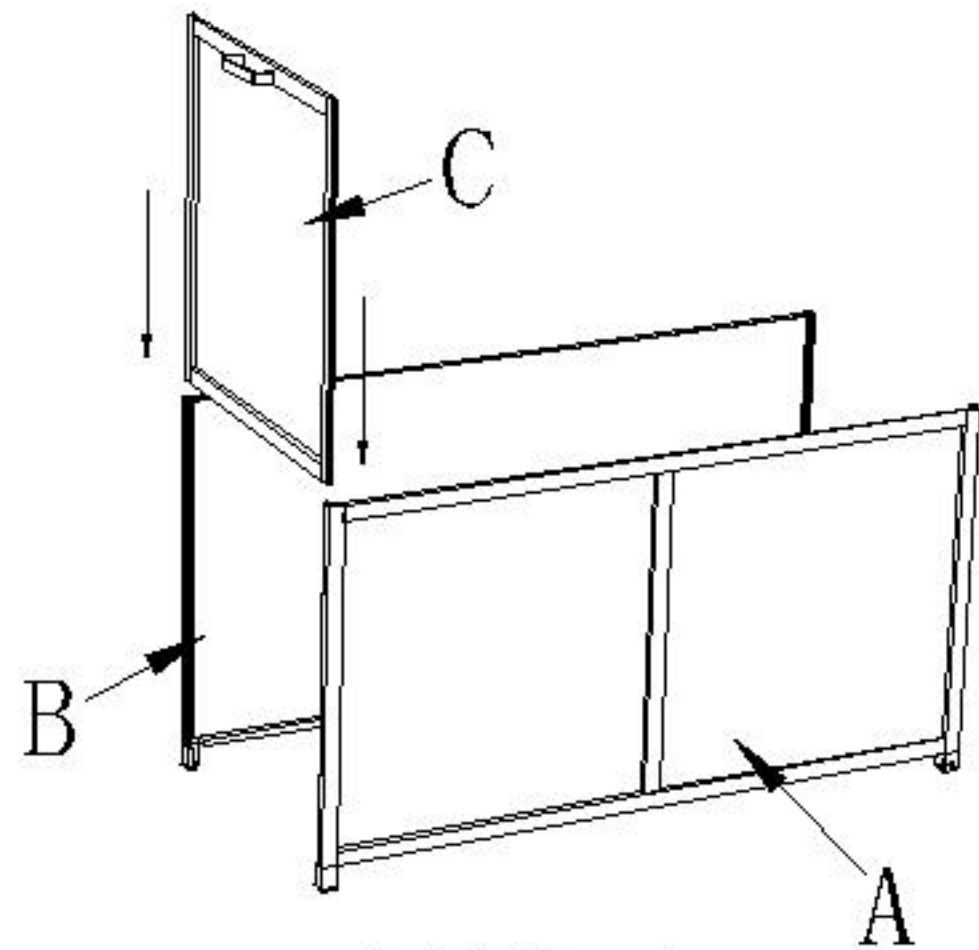

STEP:1

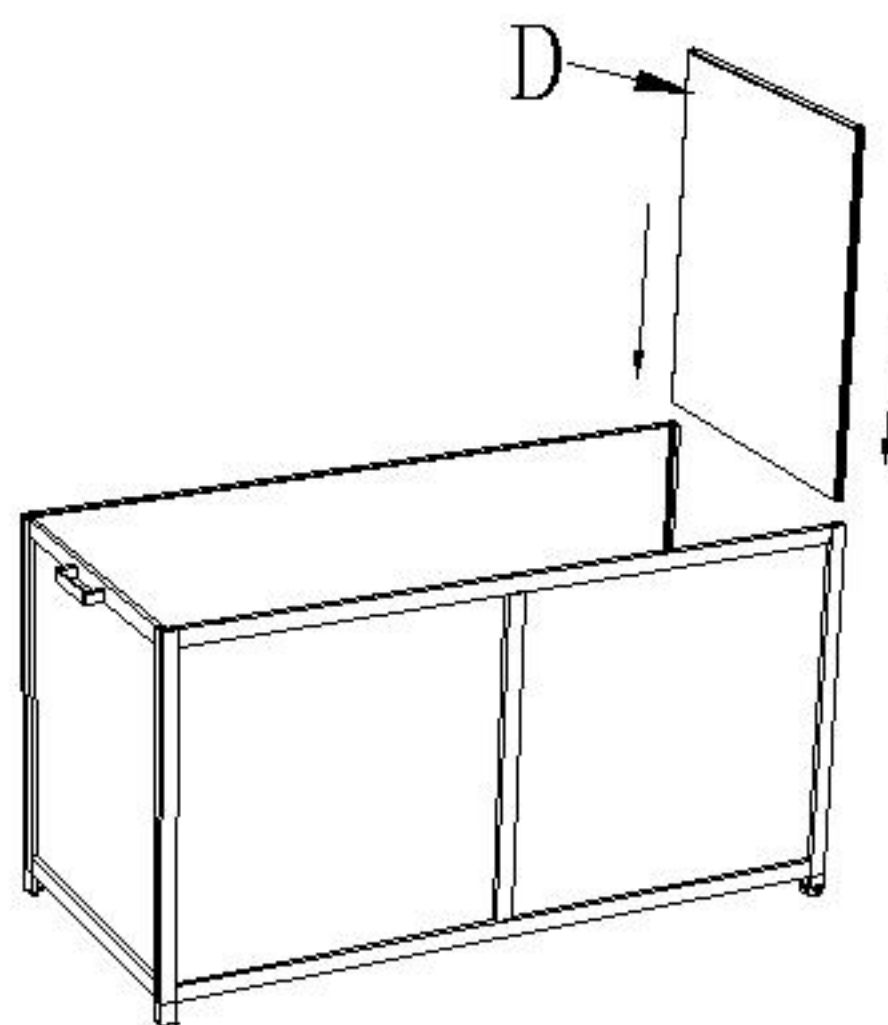

STEP:2

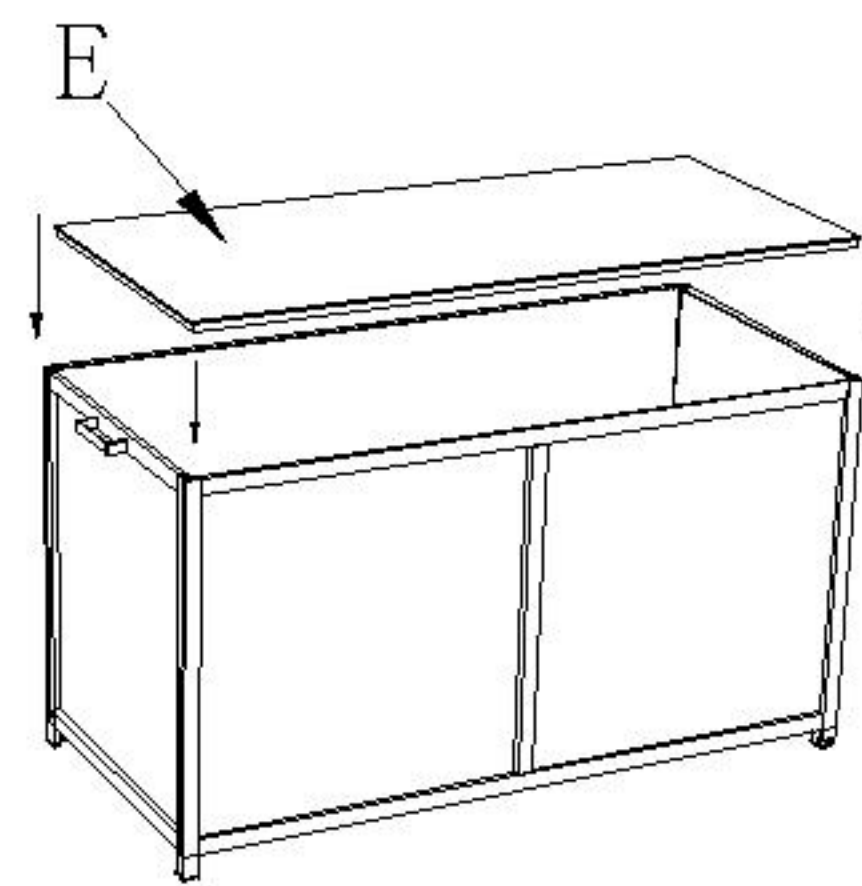

STEP:3



STEP:4

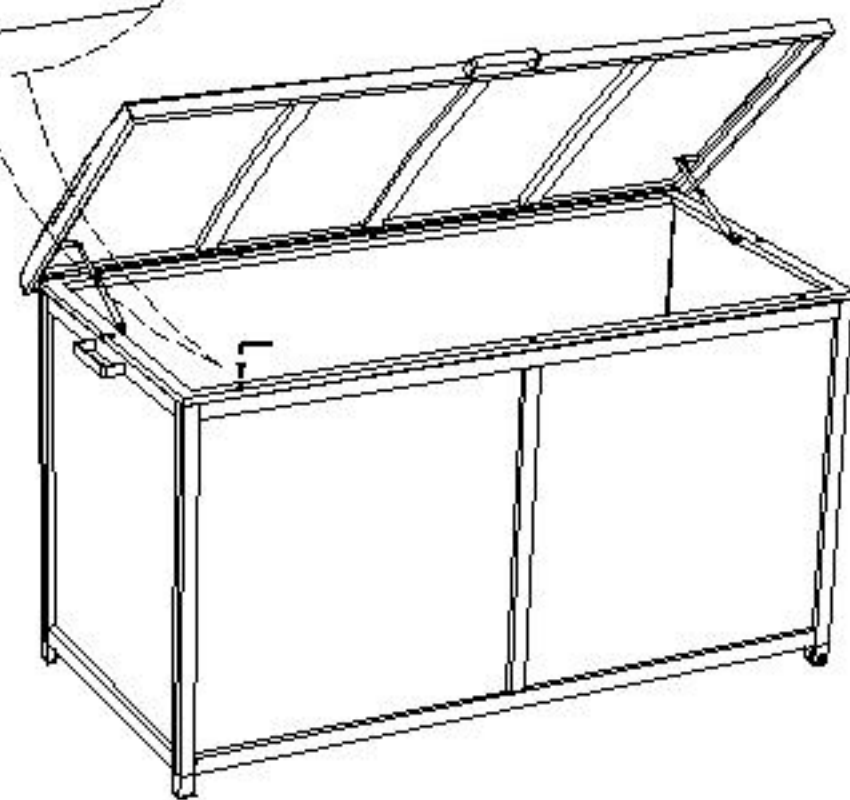
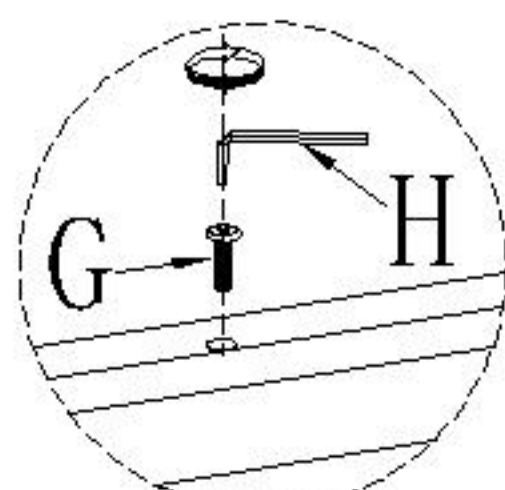

STEP:5

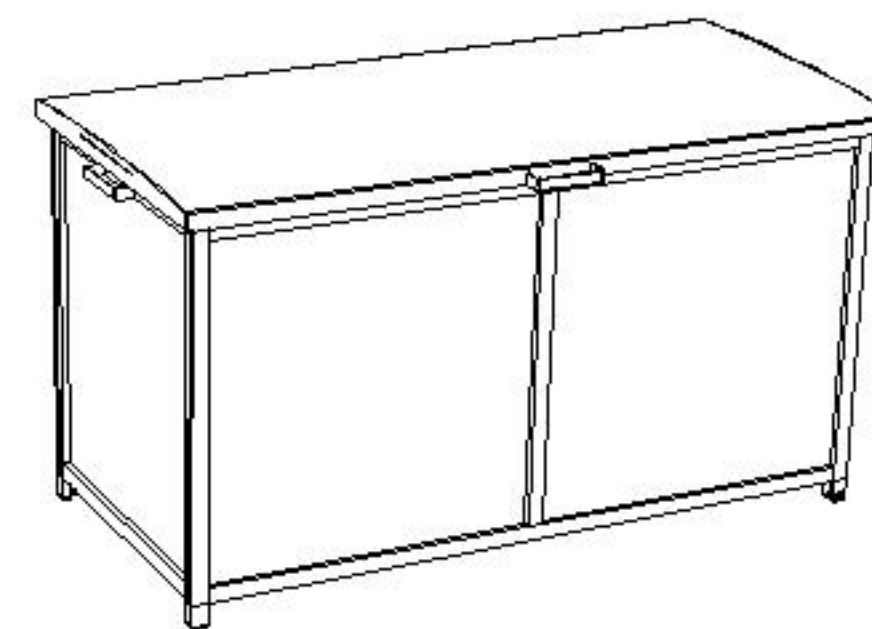

STEP:6

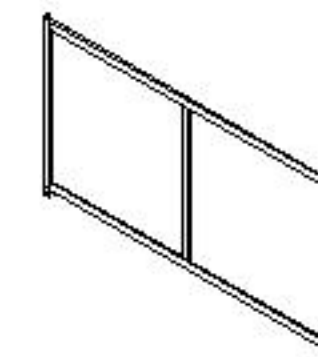

A: 1 PC

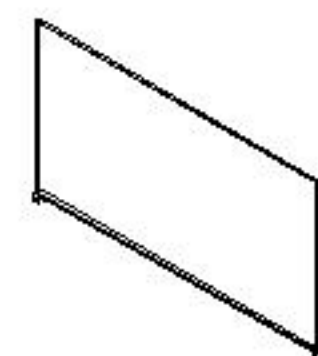

B: 1 PC

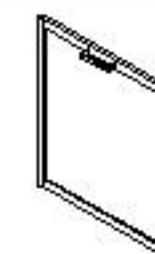

C: 1 PC



D: 1 PC



E: 1 PC

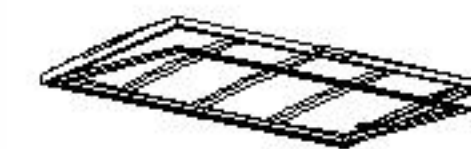

F: 1 PC



G: 10 PCS

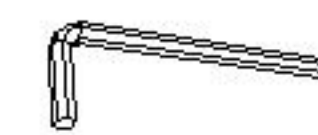

H: 1 PC