

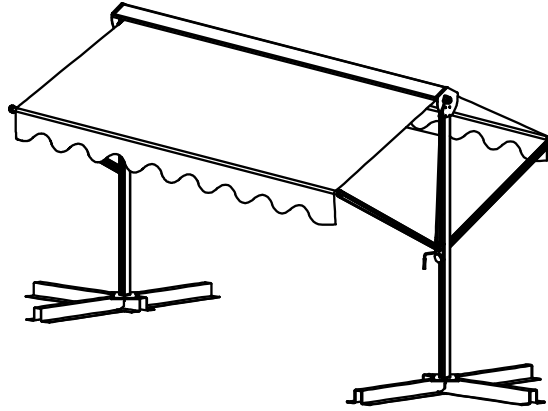

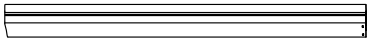

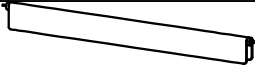

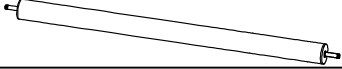







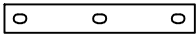







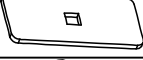









7774-8-7



REF	PARTS	QTY	DIM	REF	PARTS	QTY	DIM
1		2	2500*70 *65	2		1	3990*70
3		2	∅ 38*3905	4		12	∅ 6*1
5		2	65*70*300	6		2	135*135*8
7		4	∅ 42*16	8		4	1650*56*22
9		4	∅ 56*37	10		4	130*12*5
11		12	M6*15	12		1	∅ 14*1520
13		4	M8*16	14		12	M8*16
15		4	M8*45	16		2	∅ 10
17		4	80*38*7	18		8	M8
19		4	76*34*3	20		4	80*38
21		2	M10	22		4	M8*48
23		8	∅ 30*10	24		4	110*42*58
25		4	∅ 21*17	26		4	M8
27		1	270*256* 2.75	28		1	260*95* 1.8*4000
29		4	M8-38. 5* 18*8	30		12	∅ 8*1. 5
31		2	M10*84	32		4	M8*38
33		2	1035*98*55*1.5	34		2	657. 5*98*55*1.5
35		8	M8*16	36		2	∅ 10
37		1	∅ 3*30				

1

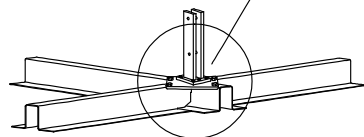
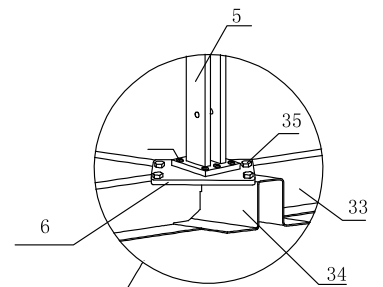
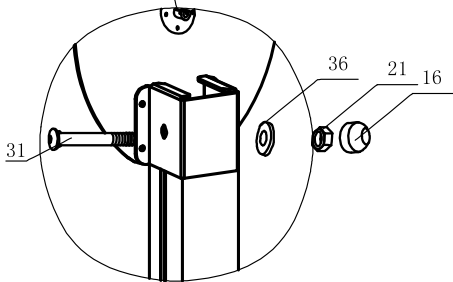
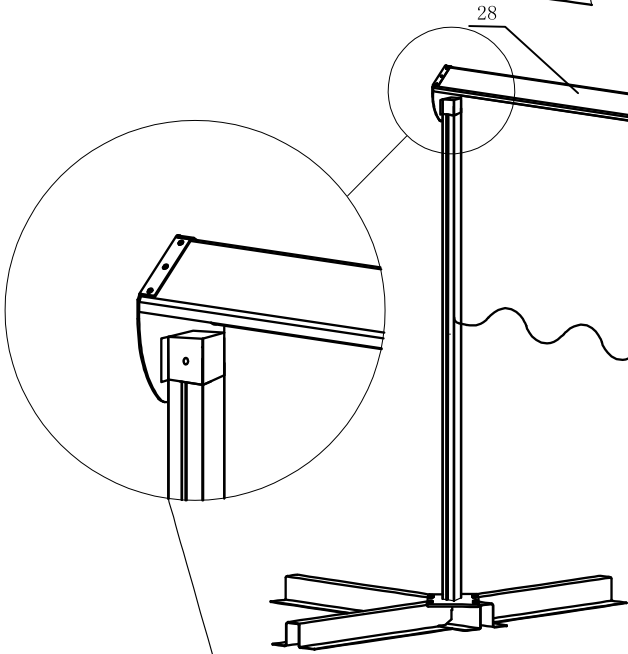
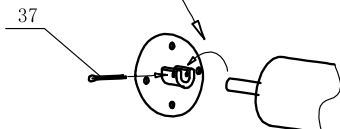
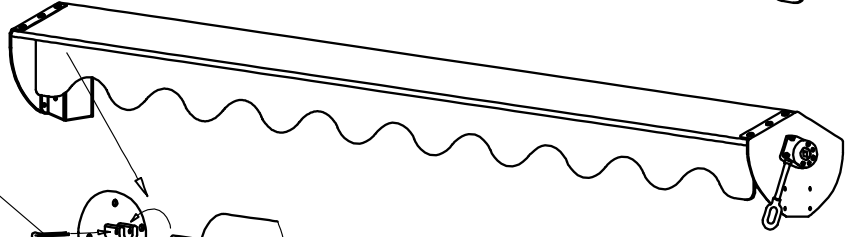
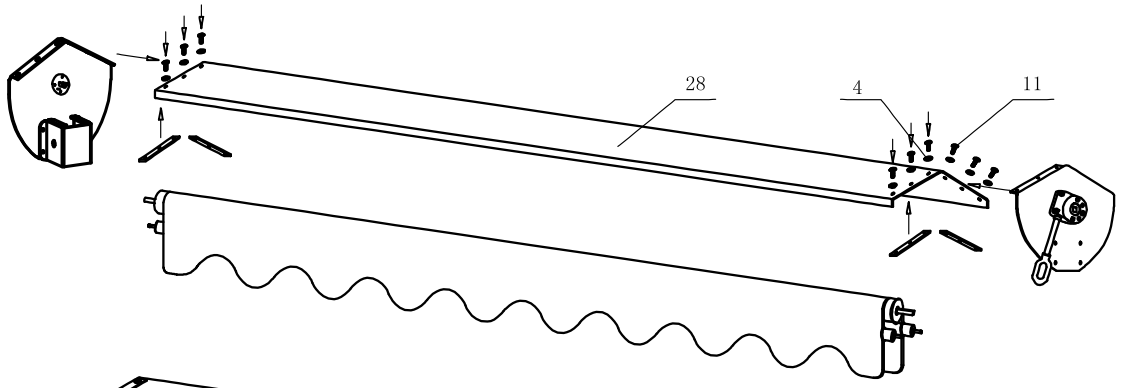

2

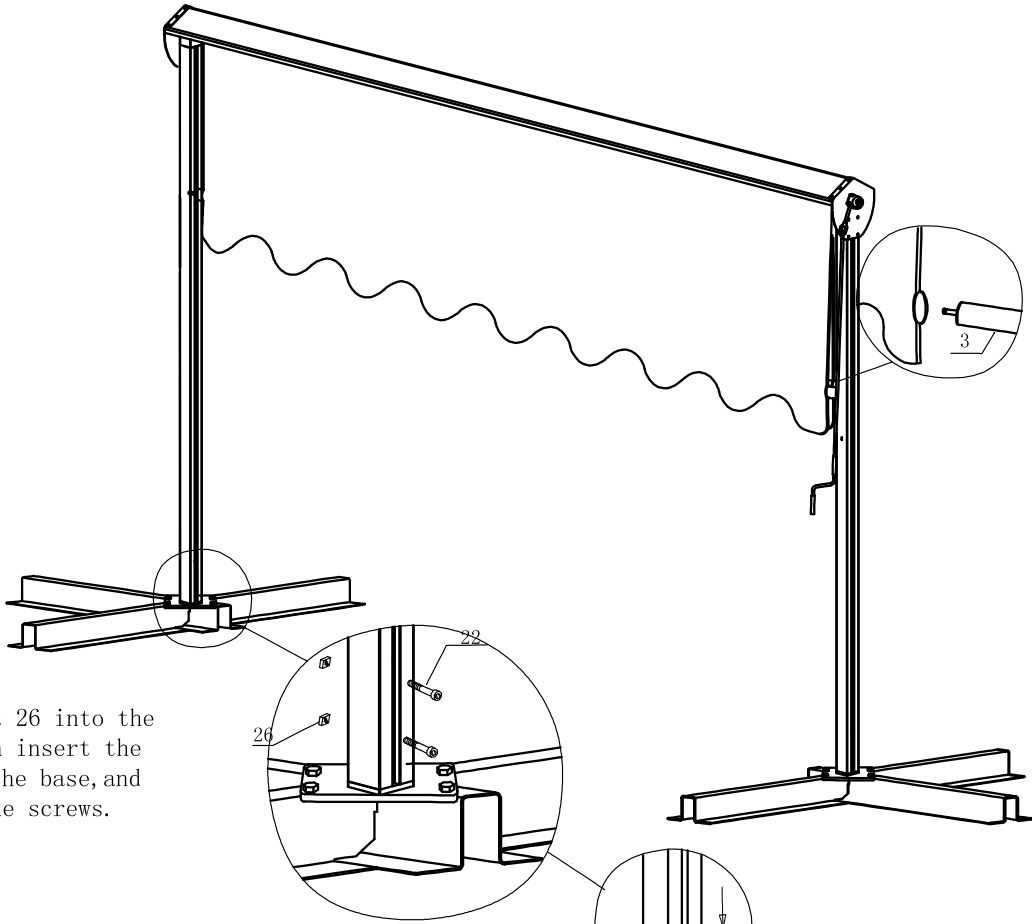

First put 26 into the pole, then insert the tube on the base, and fasten the screws.

3

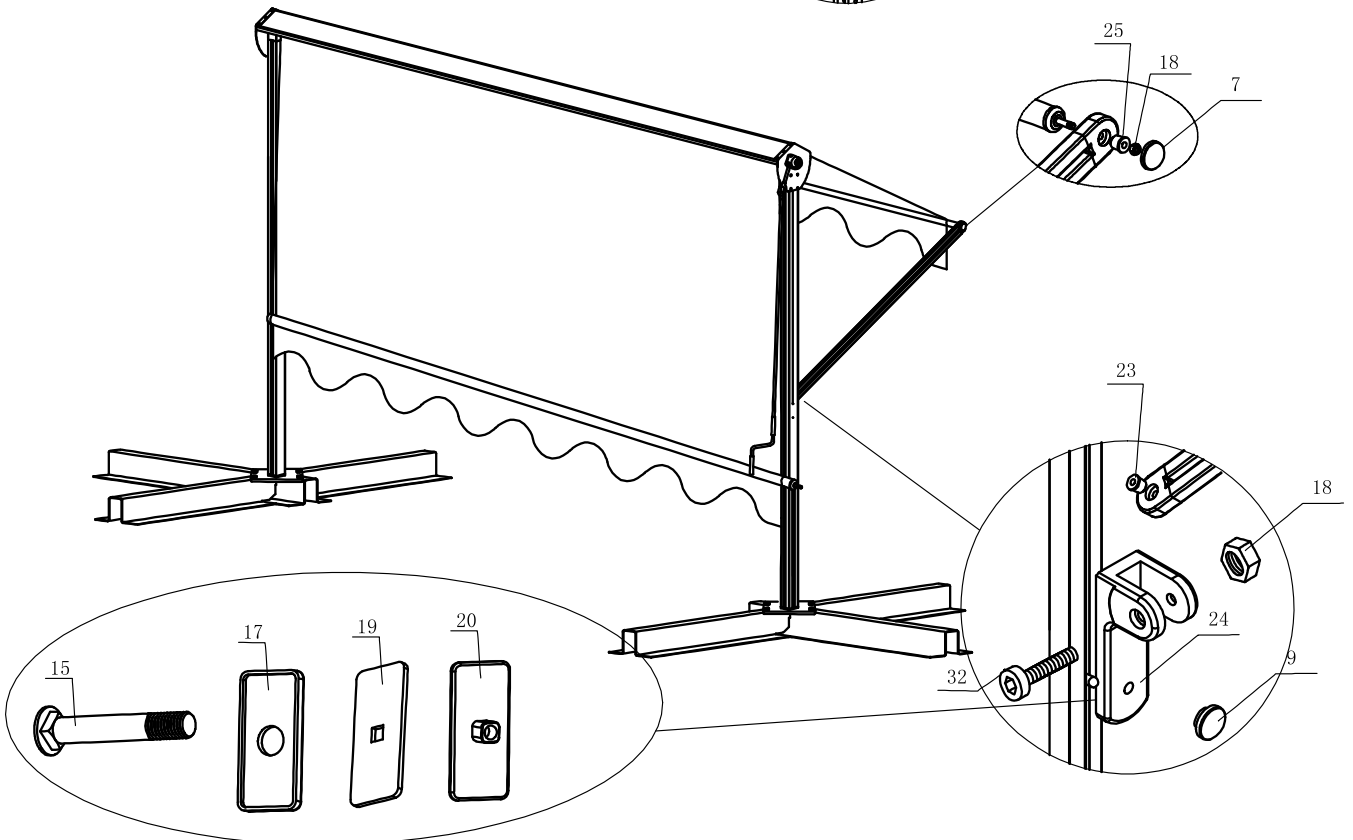

4

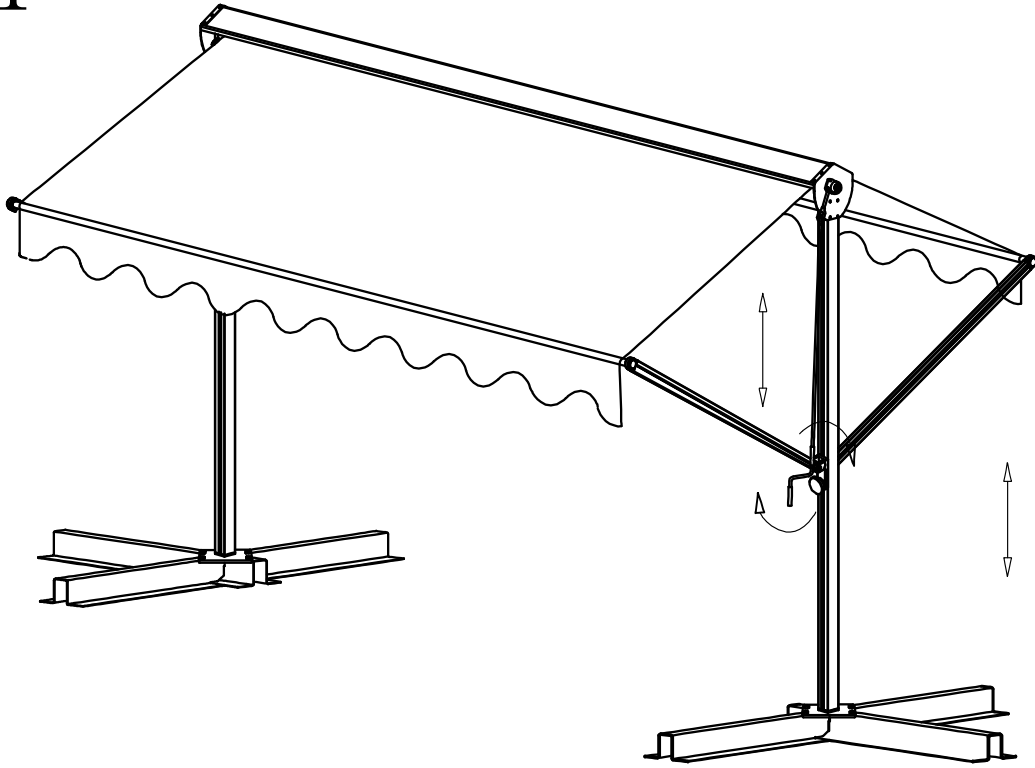

5

